

icon[®]lift



LIFTINGITALIA
COMFORTABLE HOMELIFTS



About us

LiftingItalia is a company that employs professionals with very long experience in the vertical transport sector.

It specializes in the design and production of homelifts to overcome height differences of up to 20 meters. Our homelifts are sold in 50 countries worldwide!

Made in Italy

What distinguishes us and makes us unique in the vertical mobility industry is the Italian style, combined with a focus on quality that comes from our history as a skilled craft company. LiftingItalia homelifts are functional and comfortable and allow you to move easily, in perfect autonomy and with the class that characterizes the Italian style.

LiftingItalia and AreaLift

The Group consists of two sister companies working in perfect synergy, completing each other. LiftingItalia, the parent company founded in 2003, today specializes in the production of top-of-the-range homelifts. AreaLift, founded in 2006, specializes in accessibility and vertical mobility.

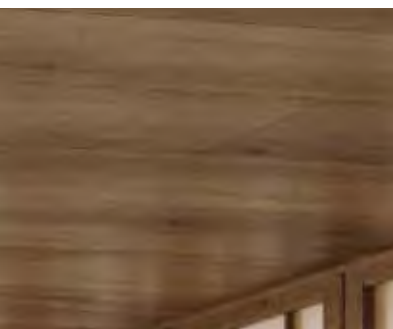

IconLift

A STYLE ICON

Elegance and style

IconLift is a mini lift featuring elegant and refined design. With a unique style, it adapts to every context, either classic or modern, helping to enhance every environment.

Furnishing accessory

The homelift has been designed with meticulous attention to detail: from a functional object to an integral part of the new living space. The Italian interior design can now count on the IconLift elevator.

Made in Italy

Design does not mean just minimalism. It can have a strong or peaceful character, it can be either histrionic or tactful, however Italian passion always beats in its heart.





IconLift

A MODERNITY ICON

Unique design

Provides continuous light lines and angles, seamlessly arranged on the same plane and perpendicular, creating a perfect harmony between wall and ceiling.

Touch Screen

Simply touch the touch screen to move comfortably in the silence of your living space, thanks to the worm-screw electric drive system: safe, reliable and ecological.

State of the art

Iconlift offers continuous LED lighting joining earth and sky in a single line. Its operation panel, with touch buttons and TFT screen, creates the horizon line toward the new perspectives of made in Italy.

IconLift

A BEAUTY ICON

Functional beauty

The core of its beauty is given by the elements arranged in a sober, functional, intuitive way. Simplicity of use, safety at the highest level and the search for beauty, represent the concept of a true lifting icon.

Environments

The cosmopolitan design features striking shapes and colours. The wide grains on doors and structure make it suitable for every environment, enhancing its uniqueness.

Materials

Every detail has been carefully designed by our professionals. The finishes of the ceiling and wall are in the same material, to provide style continuity, and have been carefully selected to match the style of your home.



IconLift

A way of life

Small lifts for homes

Our homelifts find their natural location in homes allowing to fully live the home environments. IconLift requires a **minimum space** to be placed between the home walls, where it is possible to make use of every centimetre thanks to the **customizable dimensions** with a step of 50 mm.

Landing doors

IconLift platforms lifts are provided with standard hinged **glazed doors** that guarantee style, maximum transparency, **excellent visibility**, and high safety. Elevator **entrances** can be **single, opposite, or adjacent**; compatible with your needs.

Mini elevators for indoor use

IconLift elevators are designed specifically for the interior of your home: minimally invasive structures, large use of glazed surfaces to ensure transparency and brightness.

Safety

IconLift provides **maximum operational safety** because all its devices comply with the regulations. The wide range of equipment includes:

- Emergency button
- Overload sensor
- Auto dialer
- Alarm signal
- Open door and lock check
- Emergency light
- Perimeter proximity edges
- Automatic descent to the landing in case of blackout
- Emergency buttons integrated into the panel.

You will no longer be afraid to get trapped in the elevator car.



Not only stylish features

The features that make IconLift unique are **LED lighting** with continuous **RGB light strip** and same finishes of the wall and car ceiling to make it a single piece.



Easy to install

It does not require masonry and can be installed directly on the floor or with a 50 mm pit. It will take just a few days for the lift to operate.



Minimal footprint

The **MRL (Machine Room Less) technology** and the design features make IconLift the ideal solution to combine comfort and limited space, thanks to the small size of the structure and the optimal use of the available surface.

Glazed structure

IconLift is fitted with an **aluminium structure** as standard. This element has been carefully designed and is proposed in a silver anodized or painted finish, using a wide range of colours. A solution enhanced by the choice of smoked glass.

Technology

IconLift is operated by means of floor call through the **operation panel** in the exclusively **touch** version, or through the **car controls**. These can be either touch controls (EEU) or mechanical controls (EU). In addition, the operation panel features a large **TFT display** with HD colour graphics. The technology of this homelift features a revolutionary **UDEEC controller**. Finally, the worm-screw electric drive system ensures reliability, durability, smooth and quiet motions, without forgetting the environment-friendly approach.

IconLift Outfittings

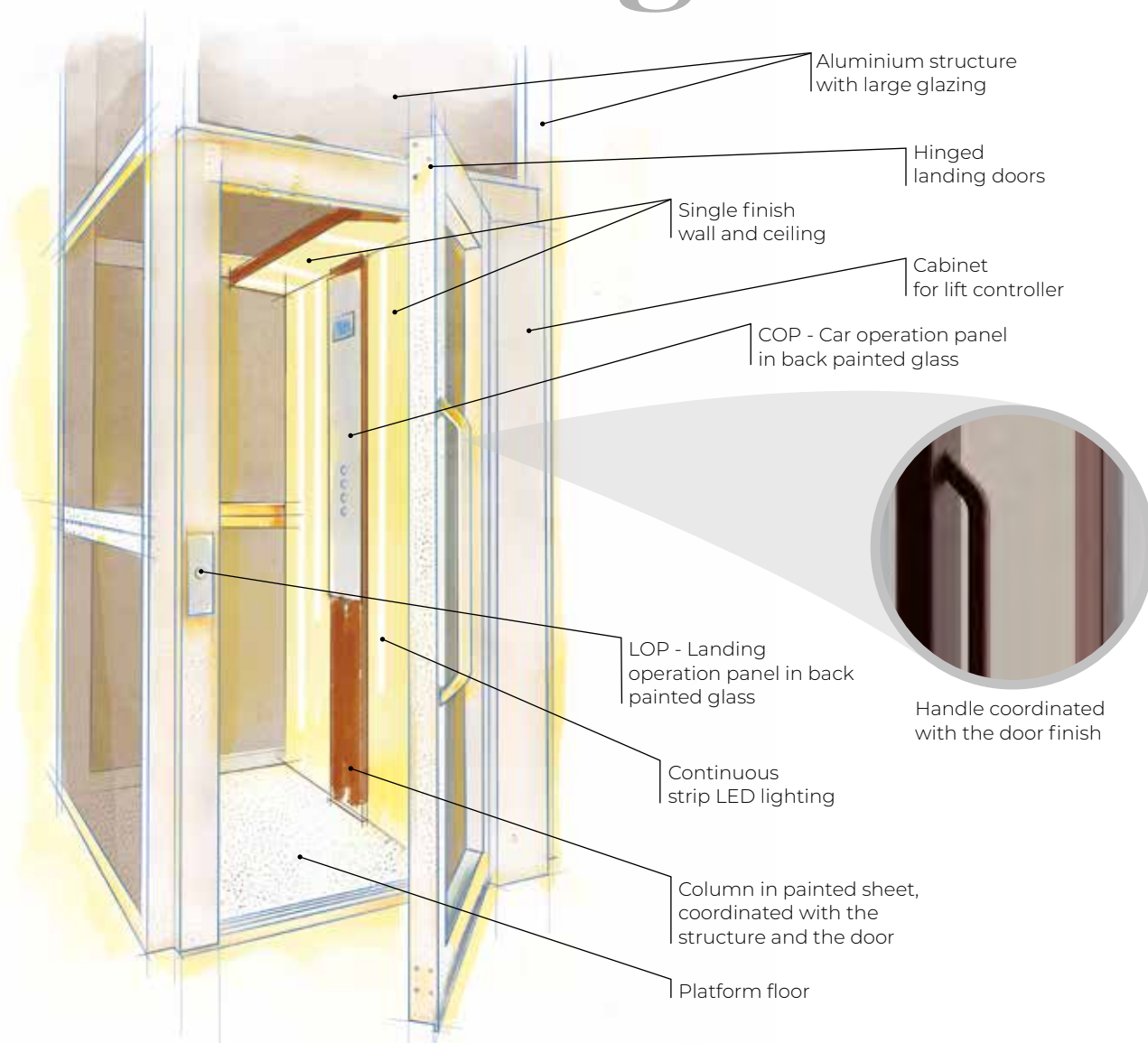

Ceiling and lighting



Continuous strip LED lighting between ceiling and wall.
 Ceiling finish: same as wall finish in HPL laminate as catalogue RAL.
 Touch push buttons (available for extra European countries).

IconLift Outfittings

Car operation panel - COP

Full height column with operation panel in back painted glass.

Standard configuration:

- Mechanical or touch push buttons
- Overload
- Alarm button
- Stop switch
- Emergency light
- Auto dialer

Landing operation panel - LOP

Back painted glass plate with touch button.

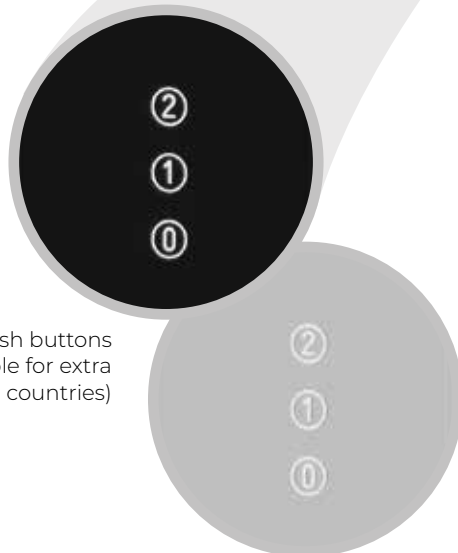

Touch push buttons
(available for extra
European countries)

IconLift Finishing and Paint

Structure - Walls - Doors

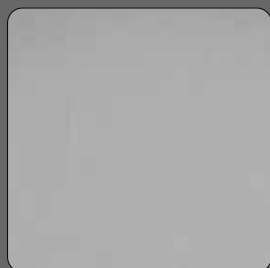

Anodized aluminium
Natural

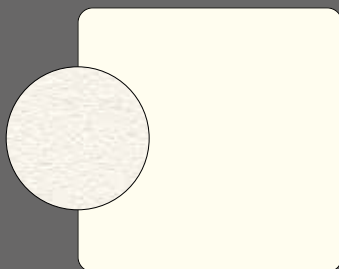

RAL 9010
Pure white

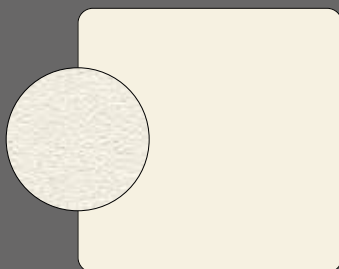

RAL 1013
Oyster white

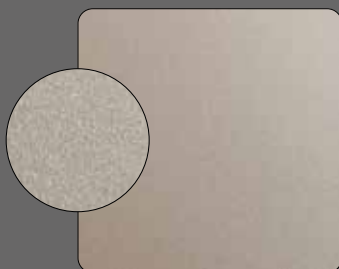

DESERT ROSE
Sand

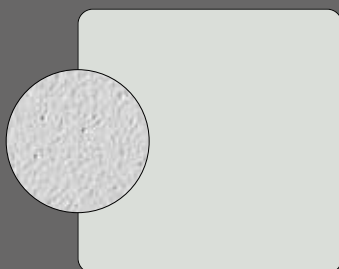

RAL 7035
Light grey

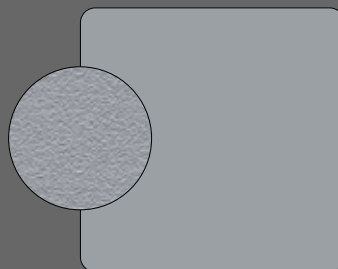

RAL 7001
Silver grey

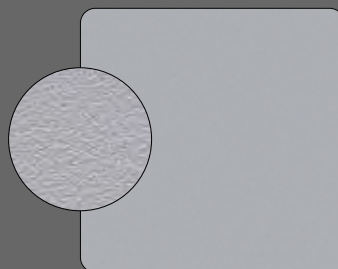

RAL 9006
White aluminium

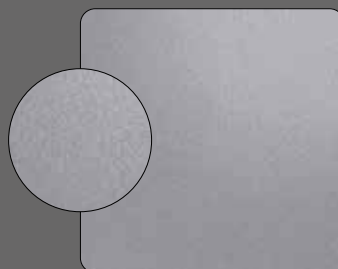

RAL 9007
Grey aluminium

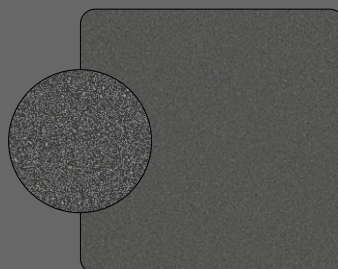

GREY MICA
Grey mica

CRINCKLED

Glass

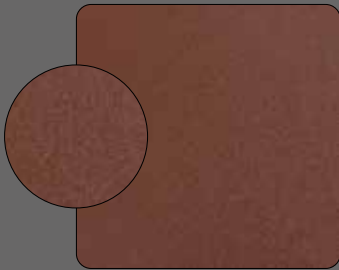

Blasted Copper
Copper

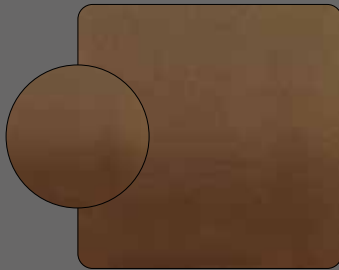

BRONZE - Y540NE3
Metallized bronze

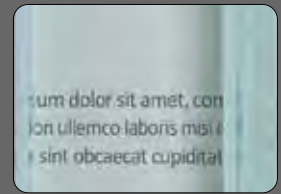

Natural Standard

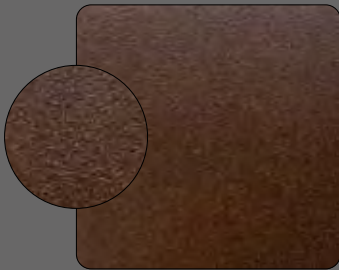

ANTIQUERUST
Corten

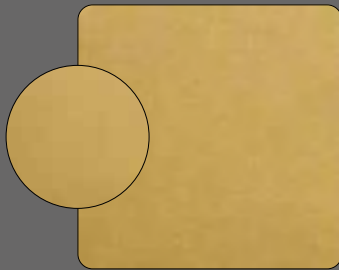

GOLD - K500Y08
Metallized gold

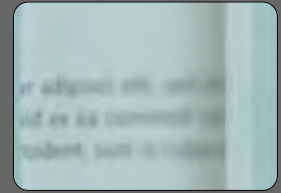

Acid Etched

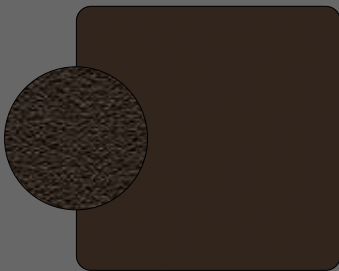

RAL 8019
Grey brown

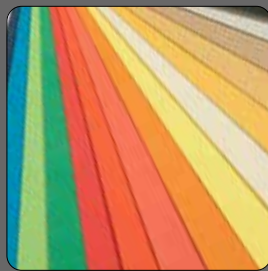

RAL paint
Complete RAL range

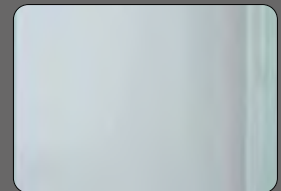

Natural Milky White

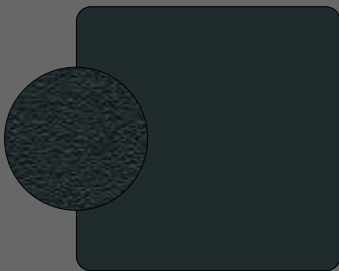

RAL 7016
Anthracite grey

SMOOTH

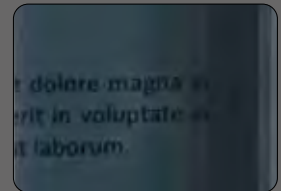

Smoke Grey

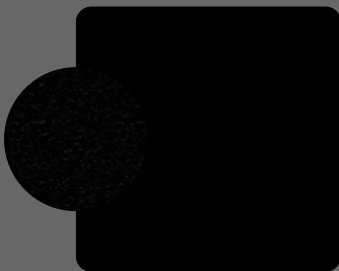

RAL 9005
Jet black

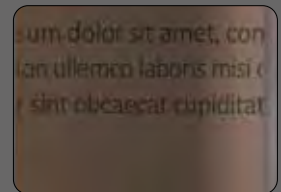

Smoke Bronze

CRINCKLED

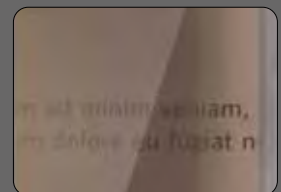

Bronze Stopsol

IconLift Finishes

Floors



GRANIT 607
Polar Ice



GRANIT 646
Black Diamond



13772
Eternal Brushed
Aluminium

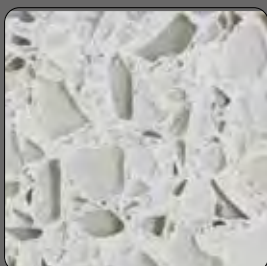

GRANIT 431
White



GRANIT 451
White Copper



13712
Eternal Brushed Chrome



GRANIT 2402
Dove Tail

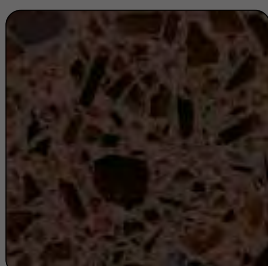

GRANIT 663
Moretti Vetro

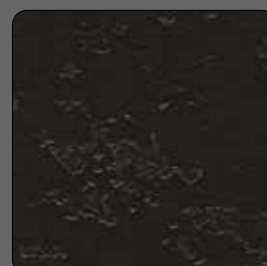

42292
Eternal Charcoal Slate

GRANITE AGGLOMERATE

**PVC "ETERNAL
COLLECTION"**

IconLift Finishes

Platform walls and ceiling

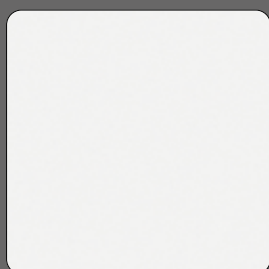

2904
White Ice - Polaris



1385 Vertical Texture
White Ash



2910
Light Grey - Polaris



410
White Ice



1381 Horizontal Texture
Transversal Oak



558
Ostuni

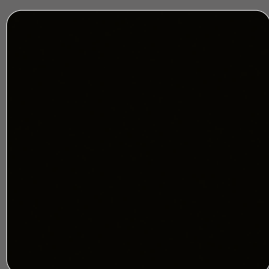

2902
Black - Polaris



414
Sand



1389 Vertical Texture
Noce Iseo



557
Ostuni



868
Medium grey

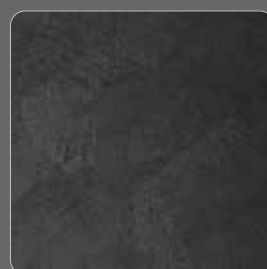

421
Ostuni

IconLift

Technical Data Sheet

GENERAL TECHNICAL SPECIFICATIONS

Load	400 kg max / 5 persons max.
Travel	13 m max.
Entrances	single, opposites, adjacents
Stops	up to 5 (in-line)
Speed	0.15 m/sec
Control	automatic and hold to run
Noise level	48 dB max
Headroom	2300 mm min.
Pit	50 mm
Suggested cycles/hour	20 max.
Power Supply	Single phase 230 vac – 50/60 HZ
Rated power	2.2 kW
Absorbed power	10A max.
Control panel	in a cabinet integrated in the frame on the bottom floor
Safety systems	perimeter mechanical edges emergency stop button alarm button overload sensors automatic emergency descent
Reference standard	D.M. 2006/42/CE – EN81.41

LIFT SHAFT

Aluminium structure SHELL model	anodized silver or painted
Structure infill	choice of glass

FULL HEIGHT WALL

Wall and ceiling finishes	HPL laminate range
Lighting	continuous strips LED
Platform height	2050 mm
Customizable dimensions	50 mm step

LANDING DOORS

Hinged landing doors LINE model	aluminium anodized silver or painted
---------------------------------	--------------------------------------

DRIVE

Traction	electrical screw driven
----------	-------------------------

IconLift Technical Data Sheet

VIEW WITH SIDE MECHANICS (right or left)

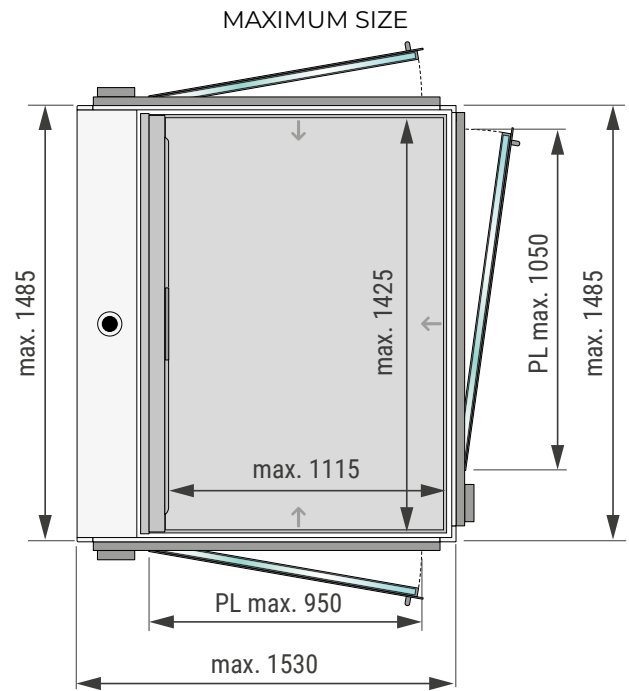
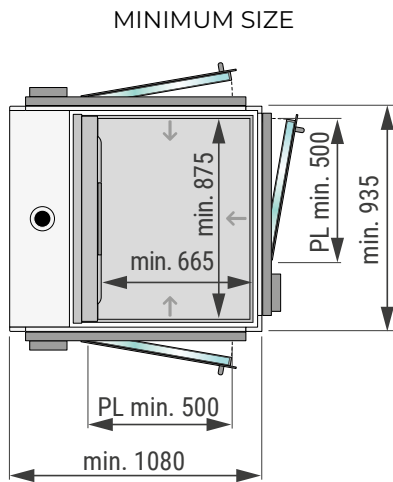

VIEW WITH OPPOSITE MECHANICS

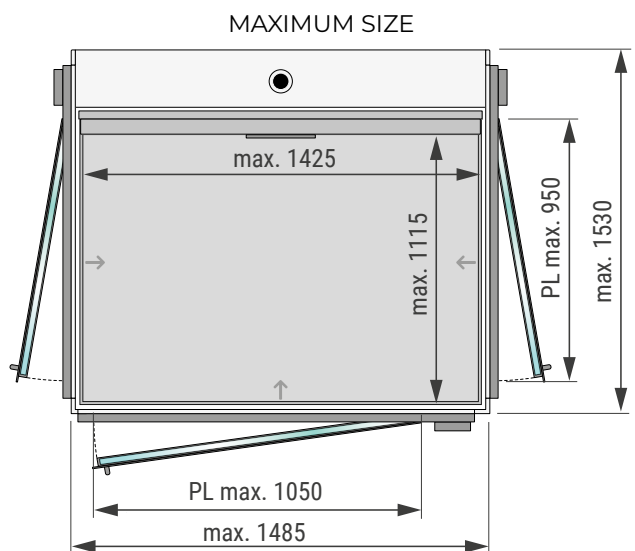
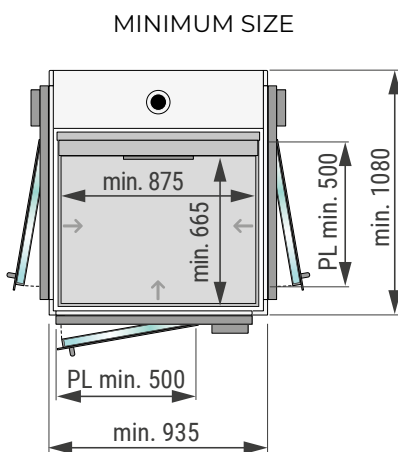

THE 50 MM STEP ALLOWS TO CUSTOMIZE UP TO 120 POSSIBLE PLATFORM DIMENSIONS.

IconLift®



LIFTINGITALIA®
COMFORTABLE HOMELIFTS

LIFTING ITALIA S.r.l.
Via Caduti del Lavoro, 16
43058 Bogolese di Sorbolo (Parma)
Tel. 0521 695311
www.liftingitalia.com



MADE IN ITALY

